



FIAMMA[®]
first choice

Installation and usage instructions **EN**

Montage-und Gebrauchsanleitung **DE**

Instructions de montage et mode d'emploi **FR**

Instrucciones de montaje y uso **ES**

Istruzioni di montaggio e d'uso **IT**

Montage- en gebruiksinstructies **NL**

Monterings- och bruksanvisning **SV**

Monterings- og brugsvejledning **DA**

Monterings- og bruksinstruksjoner **NO**

Asennus- ja käyttöohjeet **FI**

Instruções de montagem e de uso **PT**

KIT SIDE **F80**

98661-006

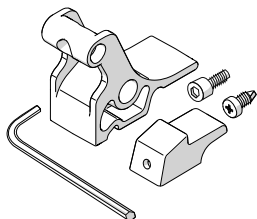

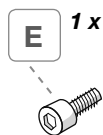
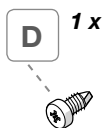
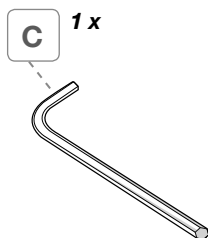
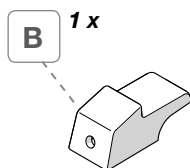
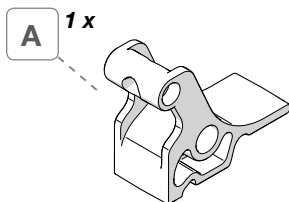
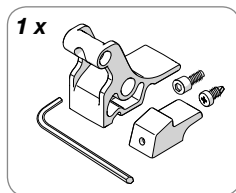

Package contents / Verpackungsinhalt / Contenu de l'emballage / Contenido del embalaje / Contenuto dell'imballo / Inhoud van de verpakking / Förpackningens innehåll / Pakkens inhoud / Innholdet i pakningen / Pakkauksen sisältö / Conteúdo da embalagem

p. 2

Installation instructions / Montageanleitung / Instructions de montage / Instrucciones de montaje / Istruzioni di montaggio / Montage-instructies / Monteringsanvisningar / Monteringsvejledning / Monteringsinstruksjoner / Asennusohjeet / Instruções de montagem

p. 4

Warranty / Garantie / Garantie / Garantía / Garanzia / Garantie / Garanti / Garanti / Garanti / Takuu / Garantia

p. 7



- EN** Check that nothing has been damaged or deformed during transport. In the event of doubts or questions concerning the installation, use or limitations of the product, contact the dealer. We recommend that the installation is carried out by qualified personnel and in compliance with current local regulations.
- DE** Bitte kontrollieren Sie, dass alle Einzelteile einwandfrei sind und nicht während dem Transport beschädigt wurden. Im Zweifelsfall oder bei Fragen zur Montage, Verwendung oder zu Einschränkungen des Produkts wenden Sie sich bitte an Ihren Händler. Wir empfehlen die Anbringung durch Fachpersonal in Übereinstimmung mit den geltenden lokalen Vorschriften vornehmen zu lassen.
- FR** Contrôler le contenu du colis et vérifier qu'aucune pièce n'ait été cassée ou déformée durant le transport. En cas de doutes ou de questions relatives à l'installation, l'utilisation du produit, contactez votre concessionnaire. L'installation doit être réalisée par des personnes dûment qualifiées et conformément aux normes en vigueur dans le pays d'installation.
- ES** Controlar que ningún detalle se haya roto o deformado durante el transporte. En caso de dudas o si tiene alguna pregunta sobre el montaje, uso y limitaciones del producto, póngase en contacto con el distribuidor. Recomendamos que la instalación se realice por personal cualificado en conformidad con las regulaciones locales.
- IT** Controllare che nessun particolare sia rotto o deformato a causa di errori di trasporto. In caso di dubbi o domande relative al montaggio, utilizzo e limiti del prodotto, contattare il rivenditore. Consigliamo di far eseguire l'installazione da parte di personale qualificato ed in conformità alle vigenti normative locali.
- NL** Controleer of er geen onderdelen zijn gebroken of vervormd als gevolg van het transport. Neem contact op met uw dealer als u vragen of opmerkingen hebt over de montage, het gebruik en de beperkingen van het product. Wij raden u aan de montage te laten uitvoeren door gekwalificeerd personeel en in overeenstemming met de geldende plaatselijke voorschriften.
- SV** Kontrollera att inga delar har skadats eller deformerats under transporten. Kontakta försäljaren om du har frågor om monteringen, användningen och produktens gränser. Vi rekommenderar att kvalificerad personal utför installationen i överensstämmelse med gällande lokala standarder.
- DA** Kontrollér, at ingen del er ødelagt eller deformeret grundet fejl under transport. I tvivlstilfælde, eller hvis du har spørgsmål vedrørende montering eller produktets brug og begrænsninger, bedes du kontakte forhandleren. Vi anbefaler, at monteringen udføres af kvalificeret personale og i overensstemmelse med gældende lokale regler.
- NO** Kontroller at ingen deler er ødelagt eller deformert som følge av feil under transporten. Hvis du er i tvil eller har spørsmål knyttet til montering, bruk eller begrensninger for produktet, ta kontakt med forhandleren. Vi anbefaler at installasjonen gjennomføres av kvalifisert personale og i samsvar med gjeldende lokale regler.
- FI** Tarkasta, että mikään osa ei ole kuljetusvirheiden vuoksi rikkoutunut tai vääryntynyt. Epäselvissä tapauksissa tai jos sinulla on tuotteen asennusta, käyttöä tai rajoituksia koskevia kysymyksiä, ota yhteys jälleenmyyjään. Anna asennus tehtäväksi ammattitaitoiselle henkilöstölle ja siinä on noudatettava paikallisia voimassa olevia määräyksiä.
- PT** Controlar que nenhuma peça tenha ficado partida ou deformada devido a erros de transporte. Em caso de dúvida ou perguntas relativas à montagem, utilização e limites do produto, contactar o revendedor. Aconselhamos a fazer executar a instalação por pessoal qualificado e em conformidade com as normas locais em vigor.

1

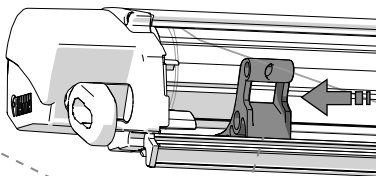
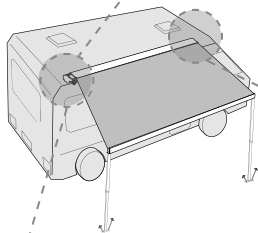

A

2

LEFT

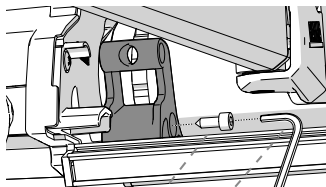

E

C

RIGHT

2

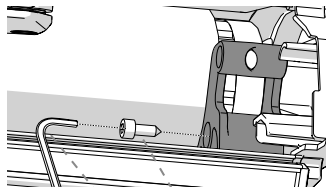

C

E

3

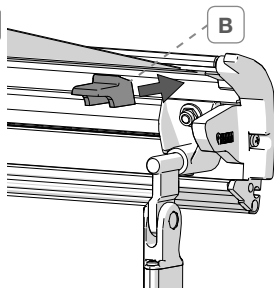
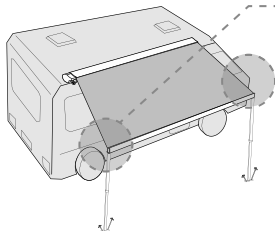

B

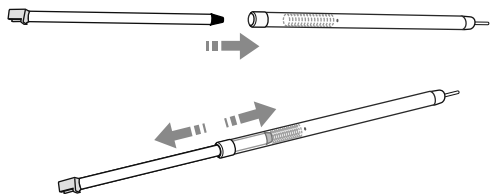
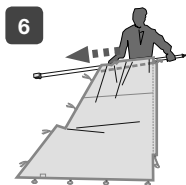
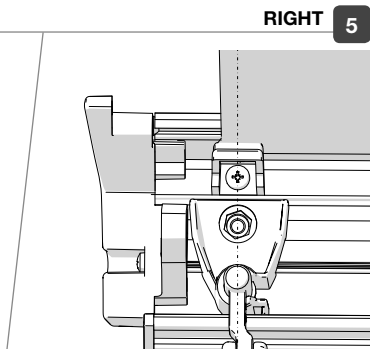
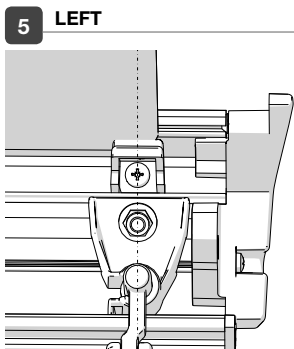
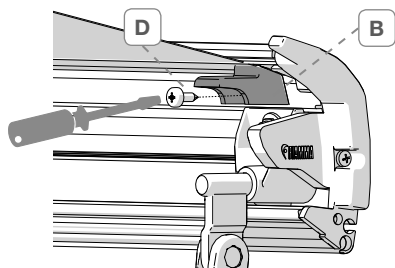
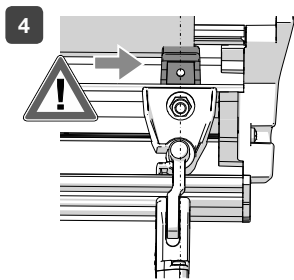

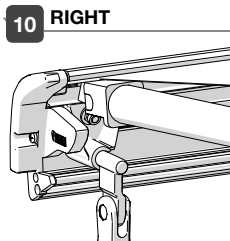
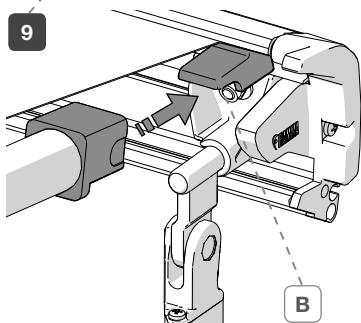
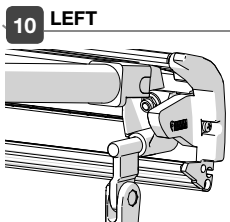
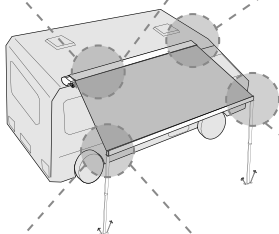
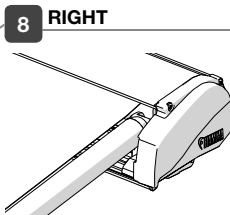
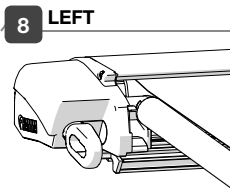
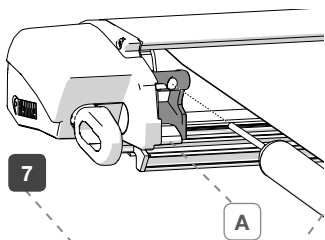



EN

Warranty Fiamma

In case of defects with regards to materials and manufacturing, the customer is entitled to the warranty in accordance with local laws and regulations of the country in which the product was purchased.

DE

Garantie Fiamma

Im Falle einer Mangelhaftigkeit der Ware, kann der Verbraucher unter den erforderlichen Voraussetzungen gegenüber dem Verkäufer von dem Garantieanspruch zu den festgelegten Bedingungen gemäss den lokalen Rechtsvorschriften Gebrauch machen.

FR

Garantie Fiamma

En cas d'un défaut de conformité du produit, le consommateur pourra faire valoir ses droits de recours en garantie selon les modalités prévues par les dispositions légales locales, pour autant que les conditions de recours soient satisfaites.

ES

Garantía Fiamma

En caso de fallos o defectos de material y de fabricación, el cliente puede hacer valer la garantía de acuerdo con las leyes y reglamentaciones del país en el que el producto haya sido comprado.

IT

Garanzia Fiamma

In caso di difetto di conformità dei beni, il consumatore potrà far valere nei confronti del venditore la garanzia secondo le modalità previste dalle disposizioni di legge locali, ove ne ricorrano i presupposti.

NL

Fiamma garantie

In het geval van gebrek aan overeenstemming van de goederen kan de consument zich beroepen op de wettelijke garantie ten opzichte van de verkoper, zoals vastgelegd in de plaatselijke regelgeving, indien de omstandigheden dit rechtvaardigen.

SV

Fiamma-garanti

Vid brister på varorna kan konsumenten åberopa garantin i enlighet med lokal lagstiftning, om omständigheterna berättigar detta.

DA

Garanti Fiamma

I tilfælde af defekter, hvad angår materialer og fremstilling, er forbrugeren berettiget til forhandlergaranti i henhold til lokale love og bestemmelse i det land, hvori produktet blev fremstillet.

NO

Fiammas garanti

I tilfelle av defekter ved varene kan forbrukeren fremme sine rettigheter i henhold til garantien overfor forhandleren, i henhold til de reglene som er fastsatt i lokale lover, der forutsetningene for dette er til stede.

FI

Fiamma-takuu

Jos tuotteiden vaatimustenmukaisuudessa havaitaan puutteita, kuluttaja voi vaatia myyjältä takuun mukaisia oikeuksia paikallisen lainsäädännön puitteissa, mikäli vaatimus on perusteltu.

PT

Garantia Fiamma

Em caso de defeito de conformidade dos bens, o consumidor poderá fazer valer, em relação ao vendedor, a garantia segundo as modalidades previstas pelas disposições de lei locais, se existirem os pressupostos para tal.



fiamma.com

Fiamma S.p.A. - Italy
Via San Rocco, 56
21010 Cardano al Campo (VA)

All rights reserved.
Fiamma S.p.A.
reserves the right
to modify at any time,
without notice, prices, materials,
specifications and models
or to cease production
of any model.